

ALUMINUM TREAD PLATE PORTABLE TOOL BOX - APTS-2448-C

APPROX WEIGHT: 92.67 lbs.
 DOES NOT INCLUDE WEIGHT OF POWER OR PACKAGING!!!

*** ANY ADDITIONS, DELETIONS, OR OMISSIONS MUST BE CORRECTED ON THIS DRAWING AS THIS DRAWING WILL BE CONSIDERED ALL INCLUSIVE ***
 ALL GRAPHICS PROVIDED ARE FOR REFERENCE ONLY. IF CERTAIN DIMENSIONS ARE CRITICAL PLEASE VERIFY THOSE DIMENSIONS WITH YOUR SALESPERSON

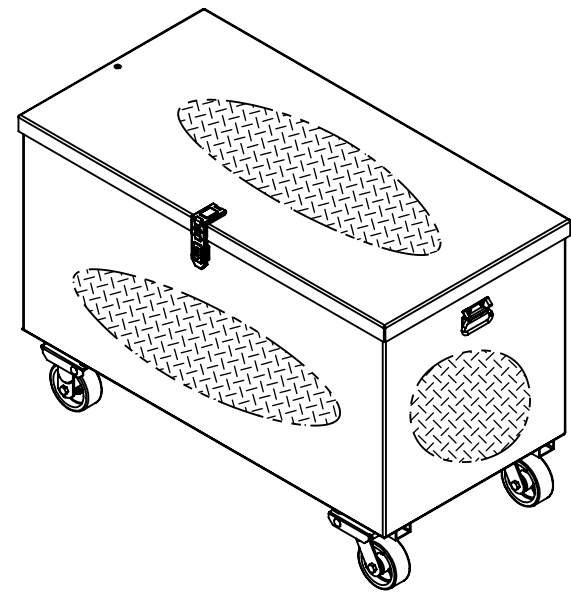
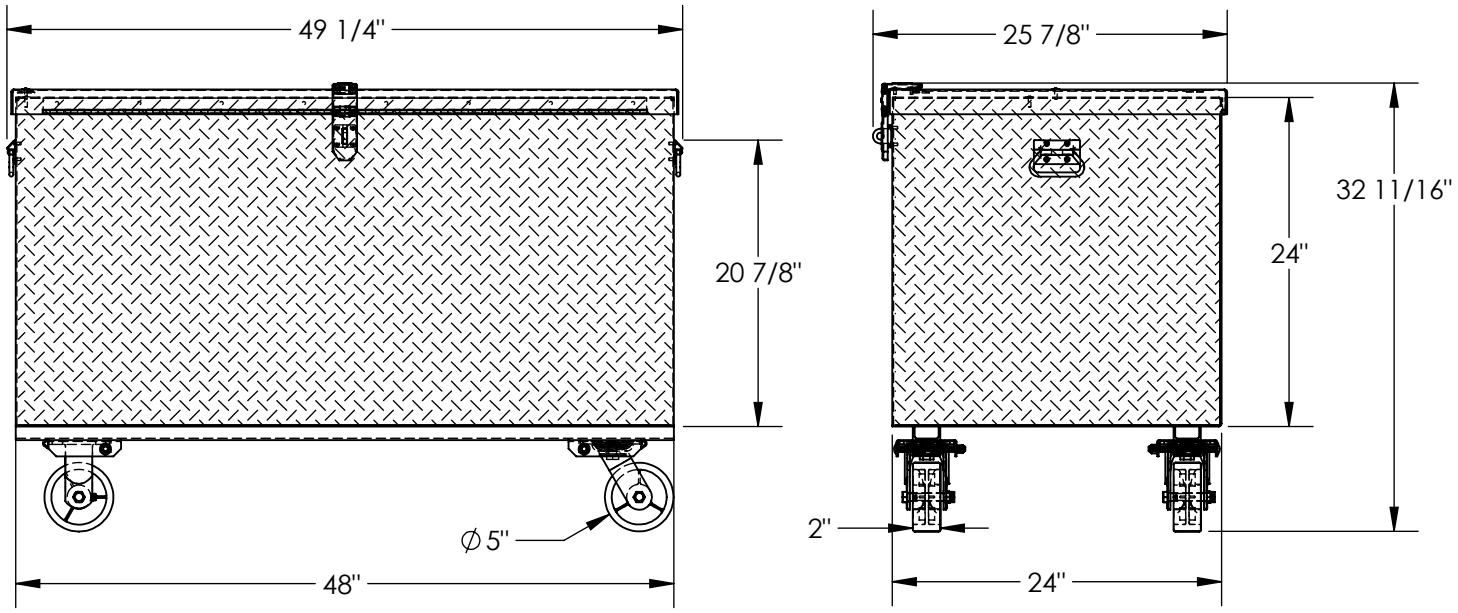

DIMENSION TOLERANCE ± 1/4"

STANDARD FEATURES

- MODEL NUMBER IS APTS-2448-C
- OVERALL WIDTH IS 49 1/4"
- USABLE WIDTH IS 48"
- OVERALL DEPTH IS 25 7/8"
- USABLE DEPTH IS 24"
- OVERALL HEIGHT IS 32 11/16"
- USABLE HEIGHT IS 24"
- MAX CAPACITY IS 2500 LBS.
- CASTERS ARE 5" x 2" POLY ON STEEL
- 2 SWIVEL, 2 RIGID

SPECIAL FEATURES

NONE

APPROVAL

I, THE UNDERSIGNED, AGREE THAT THE PRODUCT AS REPRESENTED SATISFIES DESIGN AND DIMENSION REQUIREMENTS. I ALSO ACKNOWLEDGE MY DUTY TO CONFIRM PRODUCT AND INSTALLATION COMPLIANCE WITH ALL APPLICABLE FEDERAL, STATE AND LOCAL REGULATIONS AND STANDARDS.

ANY MODIFIED UNITS ARE NON-RETURNABLE

[] As drawn [] As marked

Signed: _____ Date: _____

Printed Name: _____

LEAD TIME WILL START UPON RECEIPT OF SIGNED APPROVAL DRAWING

FOR INTERNAL USE ONLY PROJECT SIGN OFF	
SALES	
ENG.	
FAB.	
POWER	

DISTRIBUTOR'S NAME:		P.O.#
VESTIL MANUFACTURING		X
W.O.#		X
DRAWN BY:	B.NOTHNAGEL	DATE: 10/30/2015
REFERENCE:	X	SCALE: 1:14
QUOTED LEAD TIME:	X	QUOTE #
		X
FILE NAME:	41-007-001-001	